

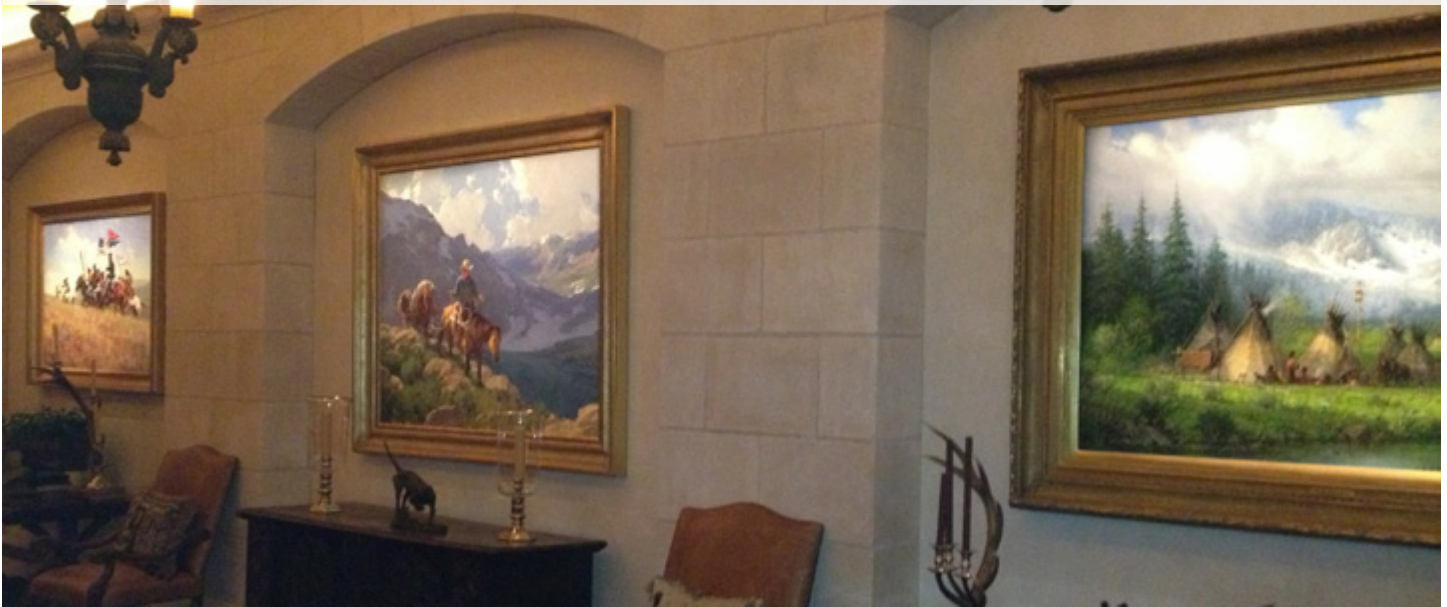

RM Series

Remodeler Housing
Contour Projector



The Phantom Contour Projector RM Series (remodel housing) is specifically designed for installation between floors and with minimal disruption to the ceiling. The low profile design permits installation in existing ceilings with joists as shallow as 10" deep. The round cover plate has a unique glare shield, tapered edge and matte white finish for a smooth ceiling transition. Phantom recessed lighting projectors are designed by a professional installer and have been engineered so a novice, do it yourselfer or qualified electrician can successfully illuminate art. The patented mounting method, precision optical design and the ability to use both shutters and custom templates make this one of the most versatile and awesome fine art lighting fixtures manufactured on the market today. By shaping the light to only the canvas, the art takes on a "Lighted from within" look that can only be seen to appreciate.



The Phantom RM Series Features

PROJECTOR: Constructed of .25 (SCH40) aluminum with two 60mm condensing lenses and two more 39mm, 75fl focal lenses standard (150fl focal lenses, engineered for longer, narrower throws, are available as a special order option.) See photometric chart on back of cut sheet or projector supplement for more information regarding lens selection.

LAMP: MR16 75-watt, 12-volt dichroic halogen lamp, 2-pin GU5.3 base with average lamp life of 3500 hours and color temperature of 3000K. Lamp Code: JCR12V-75W/FO

HOUSING: Constructed of .06 (#5052) aluminum, this sturdy housing is low profile and designed to accommodate the most demanding application.

ROTATING RING: Constructed of .08 (#5052) aluminum, this rotating ring is flexible and designed for a full 360 degree rotation with four positive locking knobs to secure the projector into position.

MOUNTING FLANGE: Constructed of .08 (#5052) aluminum, this universal cradle has multiple anchoring slots and a two-position pivot option for both vertical and horizontal applications up to 55 degrees.

MOUNTING CLIPS: Constructed of .08 (#5052) aluminum, these (4) snap in right angle clips are designed to support the round housing and secure the mounting flange and ceiling plate for ceilings up to 2" thick.

ELECTRICAL: The Junction box is designed with a quick connect/disconnect for easy installation or removal of the projector and houses an electronic 120/12V step down power supply. Magnetic transformers and 277V options are available upon request. The junction box is listed for branch circuit wiring and comes equipped with a thermal protector that provides protection against over lamping and improper installation of ceiling insulation. Thermal Protector meets NEC and UL requirements.

CEILING PLATE: Constructed of .06 (#5052) aluminum this low profile plate has a unique tapered edge, and adjustable glare shield, and matte finish for a smooth ceiling transition.



Phantom RM Series - Ordering Matrix

Sample Order Number: **RM-1-1-1-R-W**

Housing	Template	Transformer	Options	Mount	Color
RM	1	1	1	R	W
RM	1 - Shutters 2 - Metal Slide	1 - Electronic 120V 2 - Electronic 277V 3 - Magnetic 120V 4 - Magnetic 277V 5 - Electronic 230V	1 - None 2 - UV Filter 3 - 150fl Lenses 4 - Pin Hole Cover	R - Recessed	W - Matte White B - Matte Black C - Custom

Remodeler housing including 75 watt optical projector, adjustable shutters, 120V electronic transformer, 75FL lenses & unfinished cover plate.



Determine Location of Projector in Ceiling

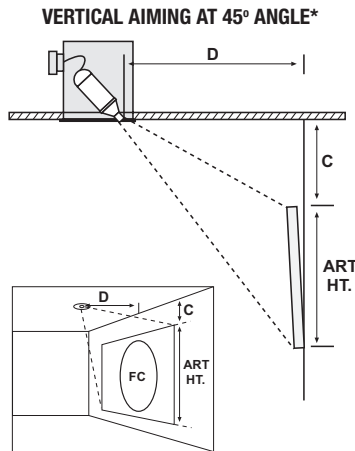

*Standard Trim

FORMULA (Standard 75fl Lenses)

**Painting Size
(60"H x 50"W @ 32" from ceiling)**

C = Distance from ceiling to top of art
D = Distance from wall

$$C + 1/3 \text{ of art height} + 4 = D$$

(Example: 32" + 20" + 4" = 56" or 6' back from wall)
Your circle of light on the wall will be **63"**
Approximately **43** foot candles of light*

HORIZONTAL BEAM*

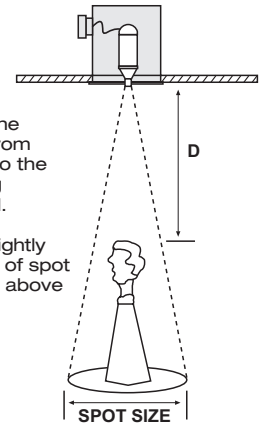

Estimate the distance from projector to the area being illuminated.

Select a slightly larger size of spot from chart above to ensure coverage.

*Pin Hole Trim

Phantom Contour Projector Photometrics

Standard 75 Focal Length Lenses Distance to Object													
		2'		3'		4'		6'		8'		10'	
Beam Spread	Beam Degree	Spot Size (in.)	FC	Spot Size (in.)	FC	Spot Size (in.)	FC	Spot Size (in.)	FC	Spot Size (in.)	FC	Spot Size (in.)	FC
VNB	43°	20	456	30	186	42	99	63	43	75	24	107	14
NB	58°	26	269	44	121	53	70	71	33	106	18	120	12
WB	67°	31	206	47	96	62	55	102	25	128	14	156	9
VWB	77°	47	117	70	52	91	30	120	14	154	8	190	5

Optional 150 Focal Length Lenses Distance to Object													
		2'		3'		4'		6'		8'		10'	
Beam Spread	Beam Degree	Spot Size (in.)	FC	Spot Size (in.)	FC	Spot Size (in.)	FC	Spot Size (in.)	FC	Spot Size (in.)	FC	Spot Size (in.)	FC
VNB	31°	11	1850	18	840	27	200	38	150	53	75	67	42
NB	32°	12	1300	19	450	30	150	39	120	55	55	70	34
WB	35°	13	1100	22	420	32	135	43	100	61	50	79	31
VWB	36°	14	1000	23	384	33	129	46	91	63	49	81	30

RM Series Housing & Projector Dimensions

HOUSING DIMENSIONS

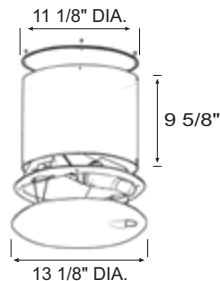

TOP VIEW

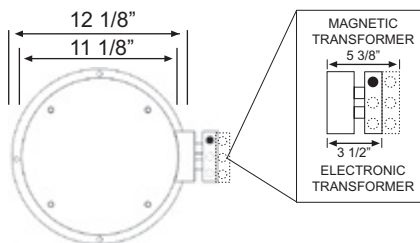

PROJECTOR DIMENSIONS

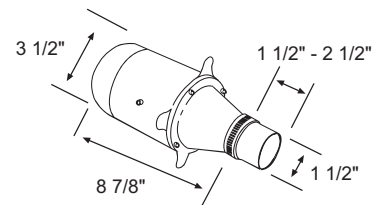

Contour Projector Template Methods

ADJUSTABLE SHUTTERS

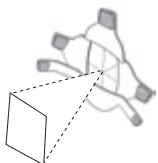

Each Phantom Projector comes with 3 different shutter assemblies that are specially designed to compliment a particular beam configuration by adjusting the light to follow the curvature of the lens. This allows for clean, straight lines, regardless of the aiming angle.

METAL SLIDE

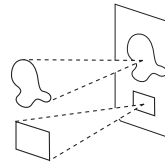

A Metal Slide is used on custom cut templates that contour the light to multiple or irregular objects such as sculptures. To illuminate multiple objects on the same wall they must be installed in a collage format.