

RML SERIES LED CONTOUR PROJECTOR

Job Name:

Catalog #:

Notes:

Recessed LED optical framing projector with **remodeler IC-Rated** housing, designed for fine art illumination in existing structures.

HOUSING

Low profile **IC-RATED** round housing is engineered for applications that require installation into an existing ceiling without damage to the ceiling. Custom mounting clips allow for ceiling thickness up to 2" and work well with drywall, wood or plaster. The removable cover plate with oval slot and custom glare shield provides easy access from below and maximum concealment of the light source.



Recessed Remodeler Housing

PROJECTOR

High performance optical framing projector with variable optics system consisting of (2) 39mm focal lenses and (2) 60mm condensing lenses designed for both long and short throws as well as off center mounting. The special Achromatic focal lenses produce crisp sharp lines without chromatic abnormalities.

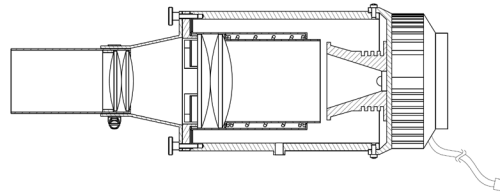

Projector with Variable Optics

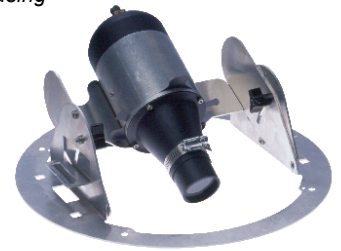

Projector in Rotating Cradle

LIGHT SOURCE

Proprietary LED light engine with a custom concentric parabolic reflector, aluminum heat sink, active DC cooling fan and CREE® XHP70 3000K LED with 90+ CRI and average lamp life of 30,000 hours.

ELECTRICAL

Includes auto-sensing 120-277V, 50/60Hz, 1750mA constant current electronic LED driver, Tri- Dimming (MLV forward phase, ELV reverse phase, 0-10V) and a non-dimming 12VDC fan power supply. Optional on-board 0-10V dimmer control available for setting output levels.

MASKING METHODS

There are three masking methods available for the LED Contour Projector: standard aluminum shutters for square or rectangular artworks, custom-cut brass templates for multiple or irregularly shaped artworks, and stainless steel gobos (Rosco® Type M) for patterned lighting effects.

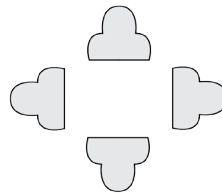

Aluminum Shutters

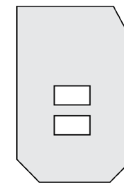

Brass Template



Stainless Steel Gobo

PROJECTOR ORDERING MATRIX

HOUSING	MASKING	LENS COMBINATION	DRIVER	PLATE	COLOR
RML	1	1	1	1	W
	1 – Shutters 2 – Template 3 – Gobo	1 – Achromatic 75fl Lenses (Wide Flood Lenses) 2 – Achromatic 100fl Lenses (Flood Light Lenses) 3 – Achromatic 150fl Lenses (Narrow Spot Lenses)	1 – 1750mA Electronic Driver 120-277V Auto Sensing 50/60Hz Forward/Reverse/0-10V Dimming (Standard) 2 – 1750mA Electronic Driver 120-277V Auto Sensing 50/60Hz Forward/Reverse/0-10V Dimming (With Onboard Dimmer Control)	1 – Slotted 2 – Center Pin-Hole	W – White B – Black

Standard Configuration includes recessed remodel housing, a white slotted cover plate, white glare shield, 120-277V auto-sensing LED/Fan drivers, optical framing projector with 39mm 75fl focal lenses and adjustable shutter masking set.

ABOUT OUR LED OPTICAL FRAMING PROJECTOR

When it comes to professional lighting art, nothing is more impressive or visually effective than an optical framing projector. A hidden light source with a controlled beam of light precisely illuminates the canvas. Phantom Contour Projectors are designed by a professional installer and have been engineered so that anyone can complete the install. The options we offer make this LED projector one of the most versatile and best art lighting fixtures on the market today.

LOCATION OF PROJECTOR IN CEILING

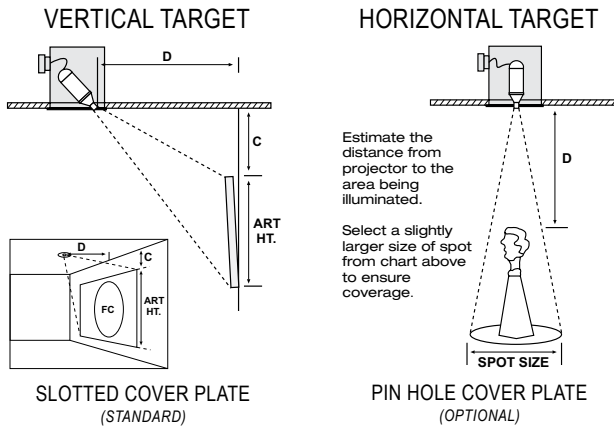

CALCULATING THROW DISTANCE:

$C + 1/3 \text{ of art height} + 4 = D$

C = Distance down from ceiling to top of the art
D = Distance out from wall where projector mounts

Example: Let's say you have a painting that is 36" High x 24" Wide and it is down from the ceiling roughly 20" to top of canvas. Doing the math, you get 20" + 12" + 4" = 36" out from the wall to the front of the housing as a starting point. The projector can be moved back, left or right as needed to avoid obstructions in the ceiling or to address reflective glare and frame shadows.

An oversized painting can be accommodated in the same way by using two (2) Contour Projectors, mounted at oblique angles. Complimentary design assistance is available from the factory.

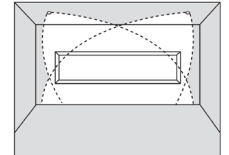

Overlapping Beam Diagram

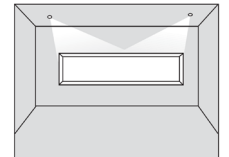

Oversize Beam Spread Result

ACHROMATIC FOCAL LENS PERFORMANCE CHART

THROW DISTANCE			1'		2'		3'		4'		5'		6'		7'		8'		9'		10'	
Beam Spread	Lens Combo	Beam Angle	Spot Size	FC	Spot Size	FC	Spot Size	FC	Spot Size	FC	Spot Size	FC	Spot Size	FC	Spot Size	FC	Spot Size	FC	Spot Size	FC	Spot Size	FC
Wide Flood Lens	75/75	60°	14"	750	28"	194	42"	101	55"	56	69"	37	83"	26	97"	20	111"	14	125"	11	139"	9
Flood Light	100/100	48°	11"	968	21"	458	32"	194	43"	120	53"	79	64"	55	75"	41	85"	31	96"	26	107"	20
Narrow Spot	150/150	28°	6"	1968	12"	1210	18"	471	24"	267	30"	181	36"	120	42"	88	48"	67	54"	55	60"	44
THROW DISTANCE			11'		12'		13'		14'		15'		16'		17'		18'		19'		20'	
Beam Spread	Lens Combo	Beam Angle	Spot Size	FC	Spot Size	FC	Spot Size	FC	Spot Size	FC	Spot Size	FC	Spot Size	FC	Spot Size	FC	Spot Size	FC	Spot Size	FC	Spot Size	FC
Wide Flood Lens	75/75	60°	-	-	-	-	-	-	-	-	-	-	-	-	-	-	-	-	-	-	-	-
Flood Light	100/100	48°	118"	16	128"	13	139"	11	150"	9	160"	7	-	-	-	-	-	-	-	-	-	-
Narrow Spot	150/150	28°	66"	37	72"	33	78"	25	84"	22	90"	17	98"	17	102"	15	108"	13	114"	11	120"	9

PROJECTOR & HOUSING DIMENSIONS

