









INSTALLATION INSTRUCTIONS (1/2)

REQUIRED COMPONENTS

-  **Lighting Strips**
Mounted on specific trim
-  **Existing Metal Tracks**
1 pair per cabinet section
-  **Driver**
(1) Job-specific requirements
-  **120" End Feed**
(1) power connector per light strip
-  **Brass Contact Pads**
(2) per Shelf
-  **Exposed Steel Supports**
(2) per shelf, not included
-  **Ring Connectors**
(2) per Shelf
-  **Brass Wood Screws**
(2) per Shelf

READ AND UNDERSTAND THESE INSTRUCTIONS BEFORE INSTALLATION – SAVE THESE INSTRUCTIONS!

These fixtures are intended for installation in accordance with the National Electrical Code and local regulations. To ensure full compliance with local codes and regulations, check with your local electrical inspector before installation. To prevent electrical shock, turn off electricity at fuse box before proceeding. Remove all components from the shipping carton. The instructions are in a step by step sequence for correct and easy assembly. Save the shipping carton and packing materials until job is complete.

IMPORTANT: THE ULTRA AE SERIES IS INTENDED FOR EXISTING CABINETS W/ EXPOSED METAL SUPPORTS.
For installation on cabinets w/o exposed metal or other applications, please look into our other strip lighting options.

1. CALCULATE DRIVER REQUIREMENTS *Available driver sizes: 20W, 40W, 60W, 96W, 150W, 200W, 300W*

Ultra lighting strips **without a lens** use standard LED tapes, producing 4.2 watts per foot. Example: a cabinet containing 10' of 4.2W Ultra Lighting Strips, 10' x 4.2 watts/ft = 42 total watts. Always allow a 20% safety factor when sizing to prevent nuisance tripping. Example: 42 watts x 1.2 = 50.4 watts, requiring a 60-watt driver. **Maximum run length per 4.2W feed is 23 feet or 96.6 watts.**

Ultra lighting strips **with a lens** use high-density LED tapes, producing either 5.0 or 7.5 watts per foot. Example: a cabinet containing 10' of 5.0W Ultra Lighting Strips, 10' x 5.0 watts/ft = 50 total watts. Always allow 20% safety factor when sizing to prevent nuisance tripping. Example: 50 watts x 1.2 = 60 watts, requiring a 60-watt driver. **Maximum run length per 5.0W feed is 20 feet or 100 watts; maximum run length per 7.5W feed is 13 feet or 97.5 watts.**

2. DETERMINE LOCATION OF DRIVER

The driver should be out of sight, but still accessible for servicing if necessary. Some electricians install it in the attic above the display, while others conceal it in the base or header of the cabinet.

NOTE: the installer should use normal voltage drop calculations when determining the distance from the cabinet. Typically, the distance should not exceed 20' from location when using 16-gauge wire. If farther, use larger gauge wire.

3. CONNECT DRIVERS TO EXPOSED METAL TRACKS

The driver will be connected to the exposed metal standards with a ring connector. This connection can be made at either the top or the bottom of the cabinet. See step 2 for information on the location of the driver; more details can be found on our driver cut sheet.

4. MOUNTING THE LIGHT ON THE HEADER

Using lead wires from the Top Header kit, install the light strip in the top of the cabinet and terminate connections. Repeat this step on each cabinet section.

5. DETERMINE LOCATION OF ADJUSTABLE SHELVES

Once the location is decided, use a brass wood screw to attach the front shelf support clips through the sides of the cabinet into the threaded holes of the cabinet and metal tracks. The brass screws assure completion of the circuit between the concealed metal components. If the shelf needs to be moved, set the location, then move the screw and front shelf clips to the desired location. **Note:** back offset shelf supports are not included.

6. INSTALL PHANTOM ULTRA LIGHTING STRIP

Noting the polarity of the metal tracks, separate the two wires on the end connecting cable and run one of them to the opposite end of the shelf, making sure this wire matches the polarity of the corresponding metal track. The lighting strip is mounted on the underside of each shelf. Position the wire that runs to the opposite end in the raceway behind the lighting strips. Trim both wires to the correct length and terminate each with the supplied ring connectors to be positioned under the contact pads. Contact pads are installed and aligned with the front shelf supports using brass wood screws. When the adjustable shelf is set in place, the contact pads rest on the shelf supports, completing the circuit and allowing the strip to be powered and illuminated. **Note:** beware of electrical shortage if contact pads touch any part of the metal trim.

INSTRUCTIONS CONTINUED ON REVERSE

INSTALLATION INSTRUCTIONS (2/2)

7. CONNECT THE DRIVER

Using a dimmer is optional, but **not required** for this product. Low voltage dimmers are not included with this product; please visit our website for a list of compatible magnetic low-voltage dimmers or call technical support.

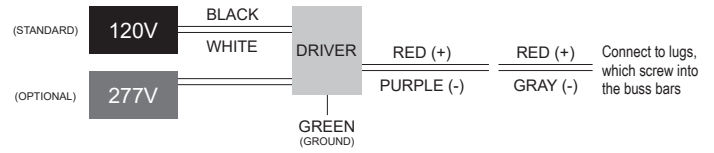

VISUAL INSTRUCTIONS AND ADDITIONAL INFORMATION

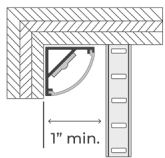

SPACE REQUIREMENT

For best results, a wood reveal should be used to conceal the fixture. For applications above eye level use a shielded trim & extend wood reveal as necessary. Allow 1" clearance between light fixture and holes.

LED LIGHTING STRIP

Each LED lighting strip is concealed by either a trim or a lensed enclosure. For best results, use a matte finish on the back of the cabinet to minimize reflections and/or glare.

POWER CONNECTION

Attach power leads from driver to existing buss bar using ring connectors provided with product.

SIDE VIEW

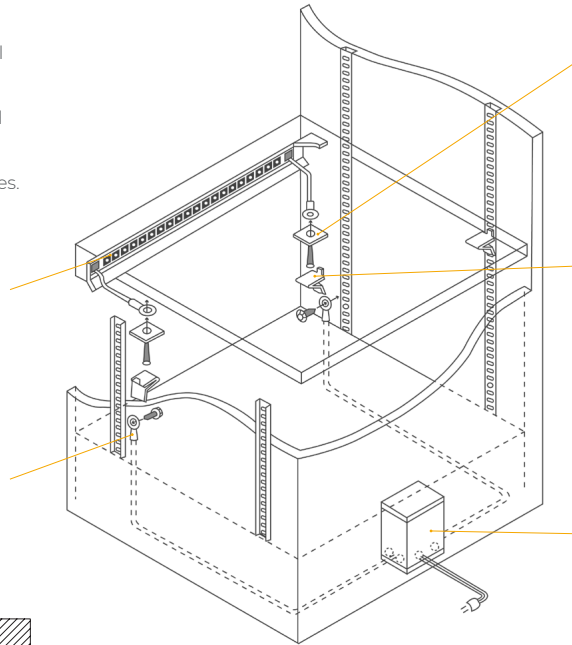
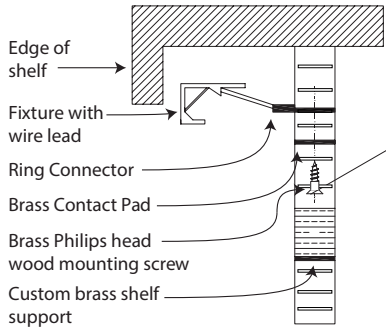

BRASS CONTACT PADS

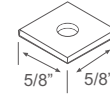

Brass contact pads are designed to transfer electricity from the shelf support clip to the individual fixtures utilizing a safe low voltage current.

Contact is made when the shelf is installed. No tools are required to rearrange the shelves!

EXPOSED STEEL SHELF SUPPORTS (BY OTHERS)

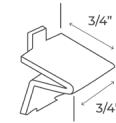

You can easily energize new or existing steel supports to conduct safe low voltage current for our exposed wiring method. This system virtually eliminates all the visible wiring and allows you to use standard shelf support clips. The use of aluminum shelf supports is **not** recommended!

DRIVER

Magnetic drivers are sized to match the total wattage of your lighting load and come equipped with one or more secondary circuit breakers. (See driver sheet for more sizing information and amperage calculations).

NOTES AND CALCULATIONS

CERTIFICATION

ETL Listed, Miscellaneous Fixtures; Conforms to UL1598 Standards. New and retrofit applications, meets the requirements of the 2023 National Electric Code Articles 410.12 Luminaires in Clothes Closets and 410.18 Cove Lighting.

TERMS & CONDITIONS

To comply with Phantom Lighting System warranty policies and ETL Standards, all lighting strips must be used in conjunction with Phantom Lighting drivers. All Phantom Lighting drivers are ETL Approved and are strongly recommended for proper operation of lighting strips. Phantom Drivers should not be located in areas with no ventilation or subject to high ambient temperatures. If ambient temperature exceeds 115°F (46°C) around the driver, the circuit breakers may nuisance-trip due to excessive heat and void any warranty.

CAUTION: FAILURE TO CORRECTLY SIZE THE PRIMARY AND SECONDARY CONDUCTORS AND/OR THE OVERLOAD PROTECTION MAY RESULT IN BODILY INJURY AND/OR SERIOUS PROPERTY DAMAGE

If you have any questions or concerns regarding your application, please contact the Phantom factory at the number listed below, a local licensed electrician, or consult the U.S. National Electric Code.

